



PVC-U window, door
and conservatory care
and maintenance guide



All together better

Contents



Introduction	3
General maintenance	4
Cleaning	
Drainage	
Weather seals	
Glass defects	
Security	6
Condensation	7
Casement windows	8
Tilt and turn windows	10
Residential doors	11
In-line patio doors	12
Tilt and slide patio doors	13
The Dales Collection composite doors	14
Bi-fold doors	17
Cleaning and maintenance log	19



Introduction

In this booklet you will find all the information required to be able to carry out any necessary cleaning and maintenance of your windows, doors and conservatories (including which parts of locks and hinges require lubrication, and how this should be applied).

The guide offers advice on how to reduce condensation within a household and also how to improve security by carrying out a few simple precautions.

If all guidance contained within this manual is followed, all products should remain at a high standard of performance and be problem-free.

The products covered within this manual are:

- ▶ **eurologik70** window and door systems
- ▶ In-line patio system
- ▶ Tilt and slide patio system
- ▶ Conservatories
- ▶ **the dales collection** composite doors
- ▶ Bi-fold doors

General maintenance



Glass cleaning

When cleaning glass use soap and water to remove any external grime. To produce a better finish you can use a household window cleaner and a soft cloth. Please be aware that any jewellery worn whilst cleaning the windows could scratch the glass if it comes into contact. Removing the jewellery or wearing rubber gloves will prevent scratching. Also be careful not to drop cloths as stones or other debris picked up may also scratch the glass. Most scratches in glass can be removed with jeweller's rouge, or an equivalent rubbing compound.

PVC-U frame cleaning

To maintain a lustrous finish, the faces of PVC-U window frames should be cleaned every three to four months with warm water and a mild liquid detergent (eg washing up liquid.) Clean with non-abrasive detergents as abrasive detergents may damage the frames. We recommend Silversil PVC-U cream cleaner, available from Eurocell branches nationwide.

Conservatory roof cleaning

Use the same method of cleaning for the polycarbonate roof as you would for the PVC-U frames. Clear gutters of leaves and debris to avoid obstructing drainage as this could

then cause overflow problems. Wash all roof panels with a soap and water solution, every four months. This will remove any debris or other deposits. Do not use any solvent based or abrasive cleaners. Under no circumstances should anyone venture onto the roof panels of a conservatory. If access above a conservatory is required, special precautions in line with current health and safety regulations need to be taken.

Drainage

Eurocell products are manufactured with a built-in drainage system. To ensure this system works efficiently, the drainage slots must remain unblocked. To ensure the window is draining correctly, remove any dirt or debris, clear drain holes and check drainage operation by flushing through with water.

Weather seals

Please ensure that you do not dislodge any weatherseals. If this occurs immediately return to correct position. If the product is damaged or broken ensure a prompt replacement by contacting your installer.

Glass defects

During the glass manufacturing process, double glazed units are susceptible to a degree of surface damage. Some of these blemishes and imperfections are unavoidable even in a controlled production environment.

Blemishes and imperfections within strict limits are deemed acceptable as they are inherent in all double-glazing. These limits are defined by the Glass and Glazing Federation (GGF). All

the glass used by your installer should be of the highest standard and will conform to the requirements of the British Standard BS6262. The following is an extract taken from the Glass and Glazing Federation (GGF) standards:

- 1 Transparent float glass used in the manufacture of double glazed units is identical to that used in traditional single glazing and will therefore have a similar level of quality
- 2 Both panes of the double glazed unit shall be viewed from the room side, standing at a distance of two metres in natural daylight and not in direct sunlight. The area to be viewed is the normal vision area, with the exception of a 50mm wide band around the perimeter of the unit
- 3 Flat transparent glass shall be deemed acceptable, if the following phenomena are neither obstructive or bunched:
 - ▶ **Totally enclosed seeds**
 - ▶ **Bubbles or blisters**
 - ▶ **Hairlines or blobs**
 - ▶ **Fine scratches, not more than 25mm long**
 - ▶ **Minute embedded particles**
- 4 Obtrusiveness of blemishes shall be judged by looking through the glass and not at it, under normal lighting conditions as described in **2**

Security



Eurocell windows and doors have been specifically designed to meet the security requirements of the relevant British Standards. These specifications are there to protect your home from intrusion. The following standards have been achieved by Eurocell:

▶ **BS7950**

The specification for enhanced security performance of casement and tilt and turn windows for domestic applications

▶ **PAS23/24**

The general performance requirements and enhanced security performance for door assemblies (applies to **the dales collection** composite doors, **eurologik70** door system, **ultimate70** door system and **aspect** bi-fold

door system). Even though our windows and doors have met the requirements of the relevant British Standards, we recommend that you take sensible precautions **at all times**, these include:

- ▶ Ensure all windows are closed when leaving your home unattended
- ▶ Lock all windows and doors which are not currently being used, this will then stop you from forgetting to do so when leaving the house unattended
- ▶ Lock all doors when leaving the house unattended or at night
- ▶ Lock all windows and remove keys keeping them out of external view but easily accessible in an emergency
- ▶ Make sure all members of the household know where to find the keys for windows and doors in case of an emergency

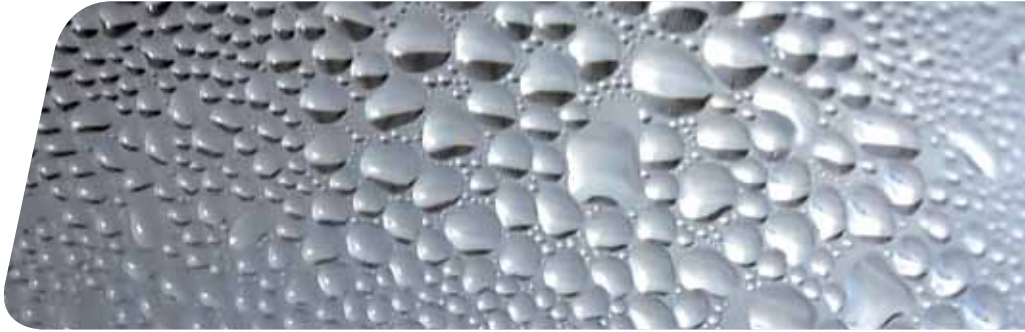

What is condensation?

Condensation is caused by the production of moisture in the air, which condenses into water when it comes into contact with cold surfaces – this moisture content is known as relative humidity (RH). The higher the temperature in a household the more moisture this warm air can hold – if the RH rises too high, mildew may form. In less well-insulated older properties or in unheated rooms the moisture in the warm air will condense when it comes into contact with a cool or cold surfaces such as metal windows or doors, cooler edges of glass sealed units, cold walls, floors or ceiling.

What is the main source of condensation?

Today's houses are built in a more energy efficient way by installing thermally efficient PVC-U draught-proof windows and doors, central heating and fully insulated walls, floors and roofs – hence the moisture produced stays within the dwelling because there are no air movement or changes. So, the main causes of condensation are: drying clothes on radiators, tumble dryers (non vented), boiling a kettle, bathing, cooking, and breathing.

How can you prevent/reduce the build up of condensation?

By installing PVC-U framed double glazed windows you have increased the thermal properties of the window and have therefore reduced the onset of condensation in the first place.

There are also a number of activities you can limit to reduce the amount of moisture produced in your home:

- ▶ If you dry clothes on radiators, confine this to one room and ventilate the room by opening a window
- ▶ When bathing or taking a shower, again try to contain this to one room by closing the internal door and ventilate with a circulation of fresh air
- ▶ Heating any rooms where condensation is forming is essential

Conservatory roofs are also susceptible to condensation under certain conditions. The effects of condensation within your conservatory can be minimised by heating at a normal domestic banding of between 10-25°C and 40-65% relative humidity, which may require ventilation via a roof light.

Casement windows



Maintenance

To attain optimum performance, the hinges will require periodical maintenance and lubrication. The hinges, pivots, sliding shoe and tracks should be kept free from dirt, debris and obstruction at all times.

▶ Pivot points

At the time of installation all pivot points should be lubricated with light machine oil, taking care to wipe away excess.

▶ Hinges

Annually, clean away dirt from hinges and apply lubrication as above.

▶ Security fixings

Check the tightness and security of all fixing screws.

▶ Handles

Clean and lightly oil external-moving parts annually. eg WD40

► Cleaning frames

To remove atmospheric grime, clean regularly with soap and water. Check drain holes are free from obstruction. If blocked, remove obstruction and wash thoroughly.

► Mastic seal

Check for any signs of cracking – if found remove and replace with new. We recommend Silversil silicone sealants, available from Eurocell branches nationwide.

► Locking system

Keep sliding mechanisms free from dirt and lubricate annually. To achieve optimum weathering performance, adjust the locking cams by using a 4mm allen key if required.

Operating instructions

To unlock the handle (key locking)

Insert and rotate the key through 90°, within the lock cylinder. The handle will now be unlocked.

To open the window

Depress and hold the button, rotate the handle through 90° and push the window outwards.

To close the window

Pull the window to its fully closed position and turn the handle back through 90°.

To lock the handle (key locking)

Turn the key through 90°, within the cylinder and remove the key.

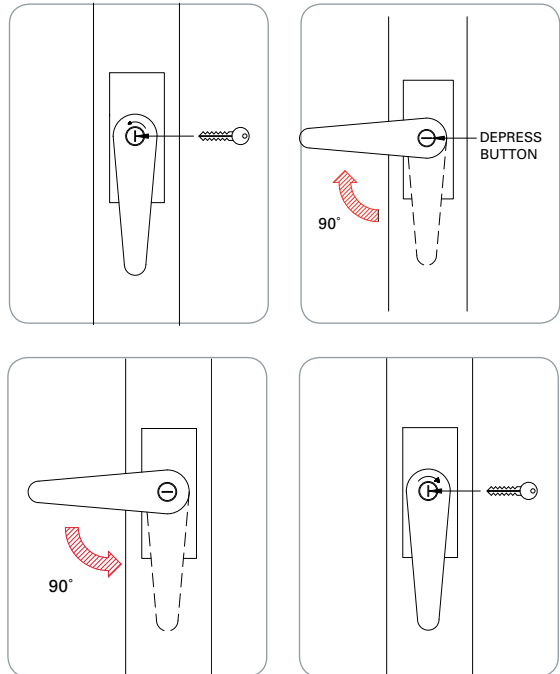

Tilt and turn windows

Maintenance

▶ Maintenance and lubrication

To attain optimum performance, hinges and loading points should be kept free from dirt and will require annual lubrication.

▶ Handles

Clean and lightly oil external-moving parts annually.

▶ Cleaning frames

To remove atmospheric grime, clean regularly with soap and water. Check drain holes are free from obstruction. If

blocked, remove obstruction and wash thoroughly to ensure correct drainage.

▶ Mastic seal

Check for any signs of cracking, if found remove and replace with new.

▶ Adjustment

The casement can be adjusted vertically at the bottom hinge and horizontally at the top hinge. To achieve optimum weathering performance, adjust the locking cams by using a 4mm allen key if required.

Operating instructions

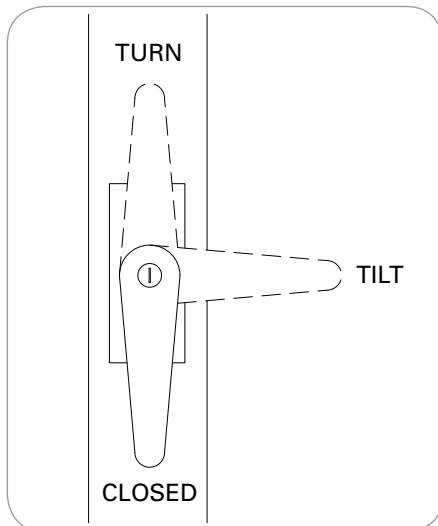

To tilt

- ▶ From closed position insert key into cylinder and rotate to unlock
- ▶ Rotate handle 90° until horizontal, window will now tilt

To turn

- ▶ From tilt position close window
- ▶ Rotate handle 90° until pointing vertically upwards, window will now turn

To lock

- ▶ From turn position close window
- ▶ Rotate handle 180° until pointing vertically down
- ▶ Rotate key to lock window

Maintenance

▶ Adjustment of centre latch and lock

Adjust latch plate pressure on spring latch by adjustment of keep with posidrive x2 screwdriver.

To achieve optimum weathering performance and acceptable handle operation, locking cams can be adjusted by using a 4mm allen key.

▶ Lock lubrication

Clean and lightly grease external moving parts and frame keeps annually.

▶ Hinge lubrication

Clean and lightly oil hinge pins annually. If open out, lubricate every six months.

▶ Letterbox lubrication

Lightly oil springs on inside and outside flaps annually.

▶ Handles

Clean and lightly oil external-moving parts annually.

▶ Cleaning frames

To remove atmospheric grime, clean regularly with soap and water. Check drain holes are free from obstruction. If blocked, remove obstruction and wash thoroughly to ensure correct drainage.

▶ Mastic seal

Check for any signs of cracking - if found remove and replace with new. We recommend Silversil silicone sealants, available from Eurocell branches nationwide.

▶ Cylinder

Do not attempt to lubricate locking cylinder.

Operating instructions

To lock

- ▶ Insert key into cylinder
- ▶ Push handle upwards (see diagram)
- ▶ Rotate key in cylinder
- ▶ The door will now be locked

To unlock

- ▶ Insert key into cylinder and rotate
- ▶ Press handle down, the door will now be open

If an alternative lock has been fitted, please contact your installer for instructions.

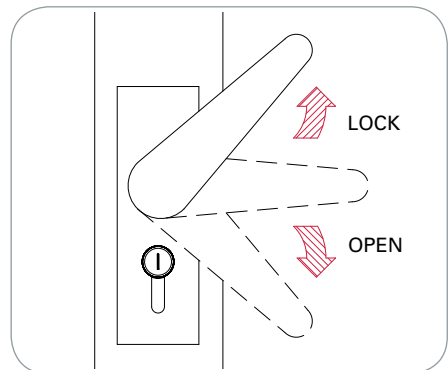

In-line patio doors

Maintenance

▶ Lock lubrication

Clean and lightly grease external moving parts and frame keeps annually.

▶ Cylinders

Do not attempt to lubricate cylinder.

▶ Track

Free any debris or dirt from drainage and track.

▶ Wheels

Do not attempt to lubricate wheels.

▶ Handles

Clean and lightly oil all externally moving parts annually.

▶ Frames

Clean frames regularly, using soapy water.

Mastic seal

▶ Check for any signs of cracking annually. If found, remove and replace with new. We recommend Silversil silicone sealants, available from Eurocell branches nationwide.

Operating instructions

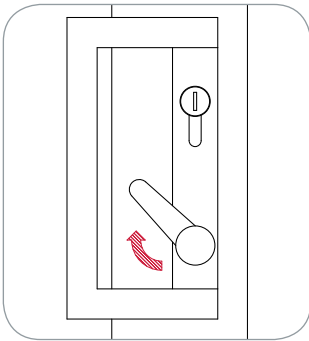

Unlock

- ▶ Insert key into lock cylinder and rotate
- ▶ Push up the lever on the handle
- ▶ Slide the door to open

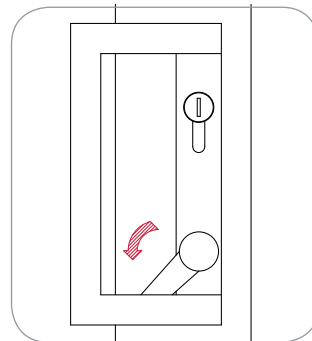

Lock

- ▶ Slide the door back to the fully closed position
- ▶ Push the lever downwards until it stops
- ▶ Turn the key to lock the door

Note: the lock cannot be operated while the door is open due to the anti-slam device

Tilt and slide patio doors



All together better

Maintenance

▶ Runner arms and stay arms

With the door in slide mode, lubricate the moving parts of the bottom runner arms and top stay arms with light machine oil. Ensure mechanism is free from dirt and debris

▶ Locking mechanism

Lightly oil locking cam slots

▶ Bottom track

Do not lubricate. Ensure that the track is clear of dirt and debris

▶ Handles

Clean and lightly oil external moving parts

▶ Lock cylinder

Do not lubricate (packed with special grease)



Operating instructions

- ▶ Operating begins in the closed position (handle vertically upwards). Insert the key and rotate to unlock. Pull handle downward 90° into horizontal position. The door will now tilt inwards. To lock in tilted position, rotate the key.
- ▶ To switch from tilt mode to slide mode, rotate the key to unlock. Move handle downward 90° to vertically downward. The door will now slide along the track from side to side.
- ▶ To close door from slide mode, slide the door to closed position, the bottom of the door will move towards the doorway. Rotate handle 180° to vertically upward, the door will now close into the doorway. Rotate the key to lock.

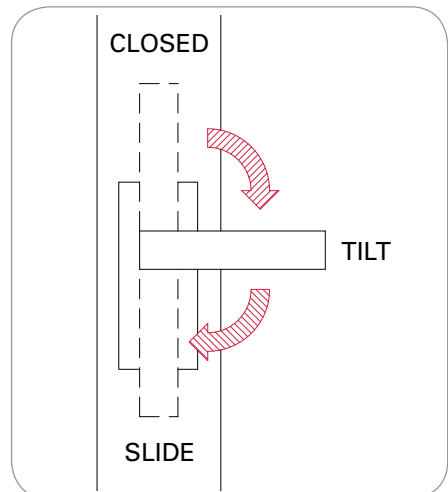

Composite doors



Maintenance

▶ Door leaf

At least every four months, clean the internal and external door facings and glass surfaces with a soft cloth and hot soapy water; rinse with water and dry off.

▶ Outer frame

PVC-U frames

At least every four months, clean the internal and external surfaces of the frame to remove atmospheric grime; always use a soft cloth with mild liquid detergent solution, rinse with water and dry off.

Outer frame seals

On an annual basis, inspect the rubber seal fitted to the outer frame (visible with the door

leaf open). If evidence of shrinking or cracking or tearing is found, remove the seal from the groove completely (a sharp knife may be required – take care when doing this) and replace with new.

▶ Hardware

Hinges

Clean the visible surface of the hinges on an annual basis. They should be kept free from dirt, debris and obstruction at all times. For colour-coated hinges (usually white, brown or gold in colour), use a soft cloth with hot soapy water, rinse with water and dry off.

Aluminium and die-cast colour-coated hinges have self-lubricating nylon bushes; do not lubricate these bushes.

Locking device

The key-way, latch and keeps should be kept free from dirt, debris and obstruction at all times.

Check operation of the key mechanism on an annual basis, with the door leaf open. If the key requires excessive force to engage the lock mechanism, then lubricate the key-way with a silicone-based spray lubricant; **do not use oil or grease.**

Lubricate the bevelled or rounded face of the latch and the latch-strike on the keep with a smear of petroleum jelly or grease. This also applies to each additional hook.

Lever handles and letterplates

Annually clean and remove dirt and debris from all moving parts. Lightly oil external moving parts with a light machine oil.

For stubborn stains, use a soft cloth with mild liquid detergent solution, rinse with water and dry off. Polish both handles and letterplates with a quality wax furniture polish, applying directly to the cloth and not the product.

Annually check that the external frame of the letterplate is flush with the face of the door. If evidence of a gap is found, tighten the fixing screws located behind the internal flap; **do not over tighten screws.** If a gap is still evident, apply a small bead of high-modulus silicone around the full perimeter of the external frame.

Threshold

The term threshold refers to the frame fitting underneath the bottom edge of the

door leaf, which acts as a weather seal and water barrier; this may be part of the frame or a device fixed directly on top of the cill (if fitted) or onto the base of the door opening. Some thresholds may include an additional fitting to the bottom edge of the door.

The threshold components should be kept free from dirt, debris and obstruction at all times.

Periodically, check that drainage holes are free from any obstruction. If blocked, remove obstruction and flush through with water to ensure correct drainage.

Annually inspect any weather seals. If evidence of shrinking or cracking or tearing is found, remove the seal completely and replace with new.

Note: A rain deflector (or 'drip bar') must always be fitted.

Precautions

Do not use solvent-based or abrasive cleaning products, or products containing bleaching agents.

Do not use metal polish or a wire brush.

When using cleaning and lubricating products, always follow the manufacturer's instructions. For cleaning products, always test a small area of the product in an obscure location first.

Bi-fold doors



Maintenance

To attain optimum performance of your bi-fold doors, the hinges will require periodical maintenance and lubrication. The hinges and tracks should be kept free from dirt, debris and obstruction at all times.

▶ **Cleaning frames**

To remove atmospheric grime, clean regularly with soap and water. Check drain holes are free from obstruction. If blocked, remove obstruction and wash thoroughly to ensure correct drainage.

▶ **Lock lubrication**

Clean and lightly grease external moving parts and frame keeps annually.

▶ **Hinge lubrication**

Clean and lightly oil hinge pins annually. If open out, lubricate every six months.

▶ **Standard handles**

Clean and lightly oil external-moving parts annually.

▶ **Aluminium roller track**

Free any debris or dirt from drainage or track.

▶ **D-handle (aspect only)**

Clean and lightly oil external-moving parts annually.

▶ **Cylinder**

Do not attempt to lubricate locking cylinder.

Operating instructions

Standard handles

To lock

- ▶ Insert key into cylinder
- ▶ Push handle upwards (see diagram)
- ▶ Rotate key in cylinder
- ▶ The door will now be locked to unlock
- ▶ Insert key into cylinder and rotate
- ▶ Press handle down, the door will now be open

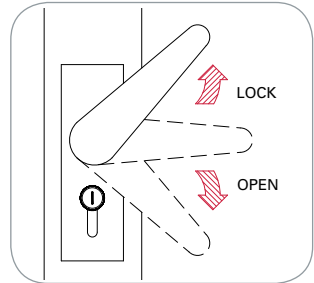

D-handle (aspect only)

To open

- ▶ Lift the D-handle to reveal the hidden lever
- ▶ Lift the lever upwards to release shoot bolts
- ▶ Use the D-handle to push / pull the doors into position
- ▶ Return D-handle to flush position

To close

- ▶ Lift D-handle and use it to push / pull doors into closed position
- ▶ Lift D-handle and move the lever downwards to engage shoot bolts
- ▶ Return D-handle to flush position



Cleaning and maintenance log

Date

Product (log which product ie. composite door, window etc)

Next due



4 Nicholas Drive, Dandenong South, Vic 3151
Ph. 03 9771 3103 Fax: 03 9706 6614

© Nu-Eco Windows Pty Ltd 2012



All together better

For more information about Eurocell products – call our customer services team on **0800 988 3047**, or visit eurocell.co.uk

Eurocell plc, Fairbrook House, Clover Nook Road, Alfreton, Derbyshire DE55 4RF



Manufacturer of the year